

MEISTER

**Installation and
care instructions
for panels**

MEISTER panels - installation and care instructions

Contents

Installation instructions	4
MEISTER fixing materials	4
Preparatory measures General information	5
Installation instructions for system panels	6
Meister Panels. style SP 800 Meister Panels. nova SP 300	6
Installation instructions for real wood and decorative panels	8
Meister Panels. craft EP 500 Meister Panels. terra DP 250 Meister Panels. terra DP 200 Meister Panels. bocado DP 300 Meister Panels. bocado DP 250 Meister Panels. bocado DP 200 Meister Panels. tertio DP 250 Meister Panels. tertio DP 200 with single-side planed battens	8
Meister Panels. craft EP 500 Meister Panels. terra DP 250 Meister Panels. terra DP 200 Meister Panels. bocado DP 300 Meister Panels. bocado DP 250 Meister Panels. bocado DP 200 with batten profile type 8	10
Meister Panels. bocado DP 300 Meister Panels. bocado DP 250 with the MEISTER special screws No. 20	12
Installation instructions for Longlife parquet and Lindura wood flooring on walls	14
Meister Parquet. longlife PD 450, PD 400, PS 300, PC 400, PC 200, PD 200, and Lindura wood flooring HD 400 with Mastercllic Plus technology	14
Mouldings	16

MEISTER fixing materials

System panels	
MeisterPanels. nova SP 300 MeisterPanels. style SP 800	Start/end clip and TOP 300 M claw screws combined with Type 8 lath profile or TOP 300 H claw screw combined with single-side planed battens (1 packet is sufficient for approx. 1.5 sqm)
Real wood panels	
MeisterPanels. craft EP 500	Clip TOP 4 combined with single-side planed battens or start/end clip and clip TOP 15 combined with batten profile type 8 or fastening clips (wall mounting only) : Minimum clip length: 16 mm Minimum clip back width: 8-10 mm Minimum wire thickness of the clip: 0.9 - 1.3 mm
Decorative panels	
MeisterPanels. terra DP 250	Clip TOP 4 (1 packet is sufficient for approx. 9 sqm) combined with single-side planed battens or start/end clip and clip TOP 15 combined with batten profile type 8.
MeisterPanels. terra DP 200	Clip TOP 4 (1 packet is sufficient for approx. 7 sqm) combined with single-side planed battens or start/end clip and clip TOP 15 combined with batten profile type 8.
MeisterPanels. bocado DP 300	Special screw No. 20 (1 packet is sufficient for approx. 30 sqm) or clip TOP 4 (1 packet is sufficient for approx. 11 sqm) combined with single-side planed battens or start/end clip and clip TOP 15 combined with batten profile type 8. For ceiling installation only clip TOP 4 or clip TOP 15 .
MeisterPanels. bocado DP 250	Special screw No. 20 (1 packet is sufficient for approx. 20 sqm) or clip TOP 4 (1 packet is sufficient for approx. 9 sqm) combined with single-side planed battens or start/end clip and clip TOP 15 combined with batten profile type 8.
MeisterPanels. bocado DP 200	Clip TOP 4 (1 packet is sufficient for approx. 7 sqm) combined with single-side planed battens or start/end clip and clip TOP 15 combined with batten profile type 8.
MeisterPanels. tertio DP 250	Fixing claw No. 3 (sufficient for approx. 9 sqm)
MeisterPanels. tertio DP 200	Fixing claw No. 3 (sufficient for approx. 7 sqm) or Fastening clips: Minimum clip length: 16 mm Minimum clip back width: 8-10 mm Minimum wire thickness of the clip: 0.9 - 1.3 mm
Longlife parquet	
MeisterParquet. longlife PD 450, PD 400, PD 200, PS 300, PC 400 and PC 200	TOP 13 clip (1 packet is sufficient for approx. 7 sqm), with PS 300 for approx. 5.5 sqm and start/end clip combined with batten profile type 8
Lindura wood flooring	
Lindura wood flooring HD 300	Clip TOP 11 (1 packet is sufficient for approx. 10 sqm) and start/end clip combined with batten profile type 8.



Preparatory measures | General information

All MEISTER decorative panels are suitable for humid rooms.

Please note that MEISTER panels are only suitable for use in interior rooms. Even the damp room panels should not be subject to direct spraying with water. The panels must be acclimatised before installation. Store them for approx. 48 hours in the centre of the room you want to work in. Do not store the packages in front of damp or freshly-wallpapered walls. Before you install the panels, the conditions must comply with the general requirements for the installation of wooden materials in interior rooms. Therefore take care that the walls and ceilings are dry, i.e. contain a maximum residual moisture content of 5 percent. Additionally, all windows and doors must have been installed and a room climate of approx. 20°C and approx. 30–65 percent relative humidity must prevail. If you should establish or expect lower humidity, this must be increased using suitable measures as otherwise gaps in the joints may occur. As the panels are only suitable for

interior rooms, please do not use them in home conservatories or for cladding around skylights because of the intense sunlight and associated high temperature fluctuations that occur here. Do not subject the panels to permanent temperatures over 110°C (e.g. ceiling spotlights, radiators etc.). Please avoid contact of the panels with all silicon products.

Before installation, check all panels in daylight for recognisable faults in colour and structure. Please note that the real-wood surface is a natural product. Any differences are a sign of its naturalness and authenticity. Goods already installed cannot be claimed for later.

You need an expansion joint if your installation surface is longer or wider than 10 metres. You cover these with the matching colour border moulding.

During installation, make sure there is air circulation behind the panelling (possibly provide a lath backing structure). You must avoid trapped air. Also important during installation is that you allow a gap of at least 10-14 millimetres (expansion joint) next to all walls and other fixed elements.



System panels

MeisterPanels. style SP 800 | MeisterPanels. nova SP 300

During installation, make sure there is air circulation behind the panelling (possibly provide a lath backing structure). You must avoid trapped air. Also important during installation is that you allow a gap of at least 10-14 millimetres (expansion joint) next to all walls and other fixed elements. (fig. 1).

For installation of MeisterPanels. nova SP 300 in damp rooms (e.g. bathrooms) please also note the following:

The panels may not be used in areas that will be directly splashed with water (e.g. shower, home swimming pool). Air circulation is absolutely necessary behind the panelling. If necessary, you must provide a lath backing structure to ensure no air is trapped. Only use corrosion-proof metal fixing elements.

Sub-structure with wooden lath

Start with the sub-structure. For this, attach dry laths that have if possible been planed on one side and that have a minimum cross-section of 20 x 40 millimetres. The laths should be placed at maximum intervals of 40 centimetres apart. Install the laths crossways to the panel lengths and fix them to create an even sub-structure. Please use suitable plugs

or screws to screw the sub-structure to the ceiling or wall at intervals of 40-50 centimetres. Correct any slight unevenness of the wall/ceiling by placing small wooden wedges underneath the laths.

Sub-structure with Type 8 wooden lath profile

The Type 8 lath profile should be placed at maximum intervals of 40 centimetres apart. Install the lath crossways to the panel lengths and fix them to create an even sub-structure. Please use suitable plugs or screws to screw the sub-structure to the ceiling or wall at intervals of 40-50 centimetres. Correct any slight unevenness of the wall/ceiling by placing small wooden wedges underneath the laths. To trim the profile, use a standard metal hacksaw or a one-hand angle grinder with a metal cutting disc.

When using the Type 8 lath profile, please note that a minimum gap of 20 mm is required when installing MEISTER recessed lights (The use of recessed lights is only admissible with MeisterPanels. nova SP 300). This must be guaranteed by fixing the profile to the wall/ceiling with a spacer of at least 12 mm.

To avoid damaging the surfaces, observe the following instructions when sawing the

elements: When you use a bench saw, keep the decorative side up, when using a keyhole or circular saw, keep the decorative side down.

Installation of Type 8 lath profile with TOP 300 M claw screw

When installing the Type 8 lath profile, attach the start/end clip and spacer (fig. 2) on the back of the first row of panels. The row of panels is placed on the sub-structure (rail). Mark the centre of the rail using a pencil. Once you have transferred this measurement to the back, attach the start/end clip to the back of the panel with a 2 cm margin using the supplied screws. The screws must be fixed in the middle of the cut-out to make it possible to correct any inaccuracy. Tighten the screws, but not too much.

If the clip does not click into place properly, it is possible that the profile was compressed during trimming. In this case, bend the profile open to its original size so that the start/end clip clearly clicks into place.

Screw the first row of TOP 300 M onto the profile and push into the panel's first groove and lock in place (fig. 3). After positioning the

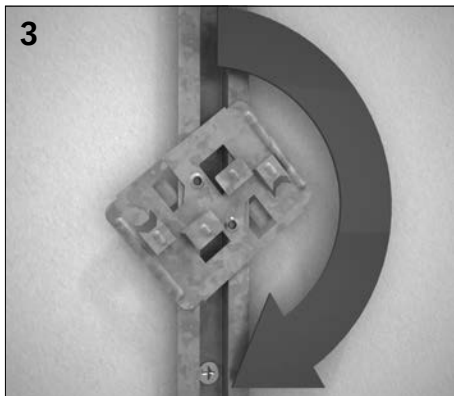
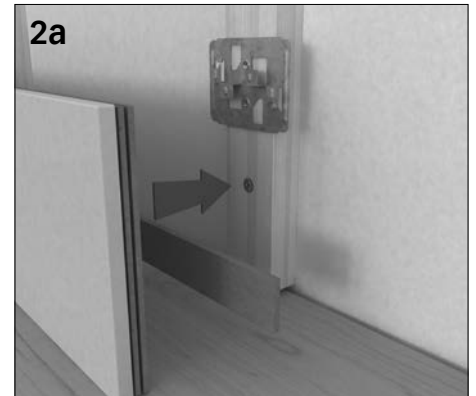
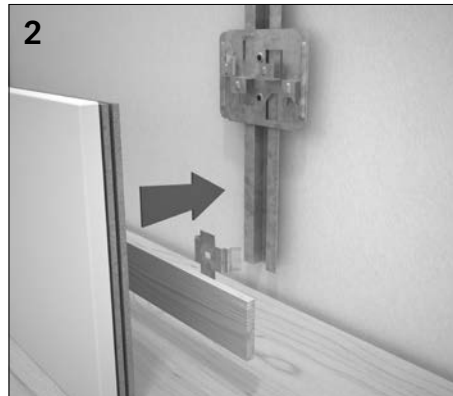
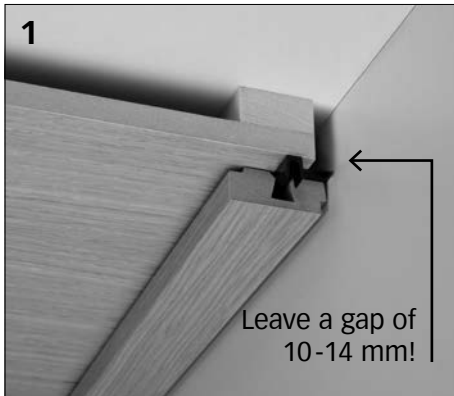

first row of panels, fix the attachment clips using screws or studs to prevent it from moving during the rest of the installation.

You can lower each panel individually by inserting it into the first or second groove, this results in the desired 3D effect. Make sure that an offset of at least 15 cm is maintained at the end joints (fig. 4). TOP 300 M claw screws must also be used on all end joints. If there is no sub-structure in this position, the TOP 300 M is just attached (fig. 4).

Each package includes three different widths of panels, install each row "end-to-end" in a different width. Install the panelling row by row in this way. Cut the last panel so that you leave a gap of at least 10-14 millimetres to the wall. If you want to pre-assemble several TOP 300 M onto the profile, this can speed up the installation of the following panels. The last row of panels can be fixed with a start/end clip like the first row.

Installation of wooden lath with TOP 300 H claw screws

When fixing onto a wooden lath, place the supplied spacers onto the back of the first row of panels and fix these using nails or screws in such a way that they will be covered later by the ceiling edge moulding or angled cover moulding (fig. 2a). Now push the TOP 300 H claw screws into the longitudinal groove. The first row should protrude by 4 mm all the way long.

With the rest of the installation you can now lower each panel individually by inserting it into the first or second groove, this results in the desired 3D effect. Make sure that an offset of at least 15 cm is maintained at the end joints. TOP 300 H claw screws must also be used on all end joints. If there is no sub-structure in this position, the TOP 300 H is not screwed on but just attached (fig. 4).

Each package includes panels in three different widths. Install each row "end-to-end" in a different width. Install the panelling row by row in this way. Cut the last panel so that you leave a gap of at least 10-14 millimetres to the wall. When you fix the last row proceed exactly as you did with the first row.

Use the MEISTER ceiling edging or MEISTER angled covered mouldings to cover the all-round expansion joints and to achieve a beautiful finish (pages 16|17).

Cleaning and care

Occasionally clean MEISTER system panels with a damp (well wrung-out) cloth that has been dipped in clean water. Do not use scouring liquid or powder, as these can damage the surface of the panels. For optimal cleaning/care of MeisterPanels. style SP 800 use the products by Dr. Schutz, e.g. dry foam.

Installation and care instructions

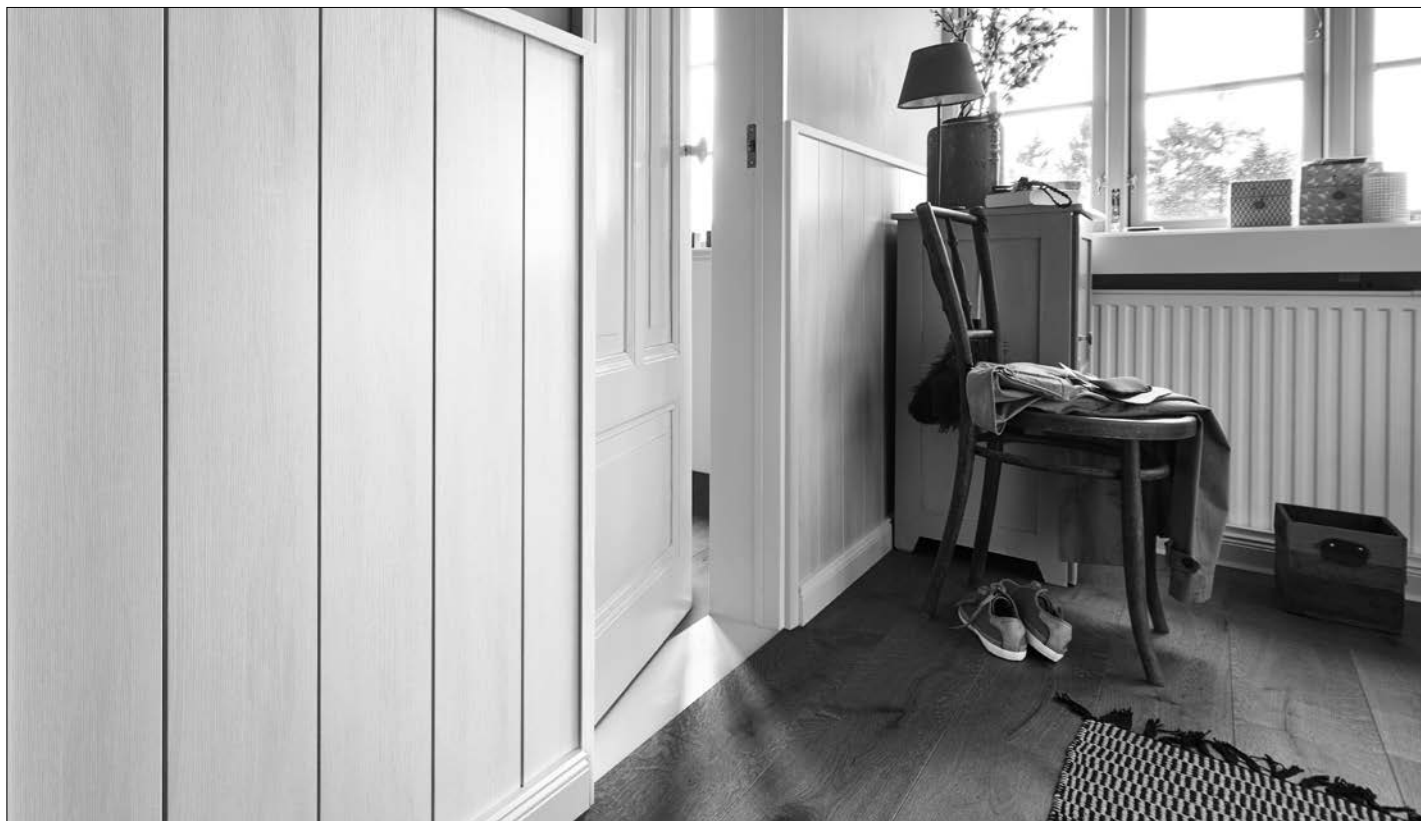

Real wood and decorative panels

MeisterPanels. craft EP 500 | **MeisterPanels. terra DP 250** | **MeisterPanels. terra DP 200**

MeisterPanels. bocado DP 300 | **MeisterPanels. bocado DP 250** | **MeisterPanels. bocado DP 200**

MeisterPanels. tertio DP 250 | **MeisterPanels. tertio DP 200** with single-side planed battens

During installation, make sure there is air circulation behind the panelling (possibly provide a lath backing structure). You must avoid trapped air. During installation it is also important that you allow a gap of at least 10–14 millimetres (expansion joint) next to all walls and other fixed elements (fig. 1).

For installation of decorative panels in humid rooms (e.g. bath-rooms) please also note the following:

The panels may not be used in areas directly exposed to splashing water (e.g. showers, home swimming pools).

Air circulation is absolutely necessary behind the panelling. If necessary, you must provide a lath backing structure to ensure no air is trapped (see fig. 2 for lath backing structure). Only use corrosion-proof metal fixing elements.

MeisterPanels. craft EP 500

Using fixing clips (only possible for wall installation)

Due to the large number of fixing clip types, not all possible variations can be dealt with here.

The clips must comply with the following minimum measurements to guarantee long-term secure fixing:

- Minimum clip length: 16 mm
- Minimum width of clip top: 8 to 10 mm
- Minimum clip wire thickness: 0.9 to 1.3 mm

Safety instructions

Please note that the clip top must be flush with the groove side surface for correct installation and fit of the panels. Make sure the clip top does not “shoot” through the groove side wall (see drawing).

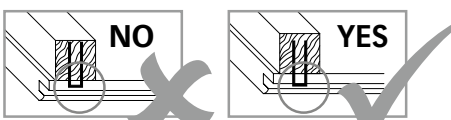

Start with the sub-structure. For this attach dry single-side planed laths that have a minimum cross-section of 20 × 40 millimetres if possible. The laths should be placed at maximum intervals of 40 centimetres apart. Install the laths crossways to the panel lengths and fix them to create an even sub-structure. Please use suitable plugs or screws to screw the sub-structure to the ceiling or wall at intervals of 40–50 centimetres. Correct any slight unevenness of the wall/ceiling by placing small wooden wedges underneath the laths.

To avoid damaging the surfaces, observe the following instructions when sawing the elements: when you use a bench saw, keep the decorative/veneer side up, when using a keyhole or circular saw, keep the decorative side down.

Start by laying the first complete panel in the left-hand corner of the room with the tongue facing the wall. You must saw off the tongues on the short and long edges of the first panel. Saw off only the tongues on the long edges of all the other panels in the first row.

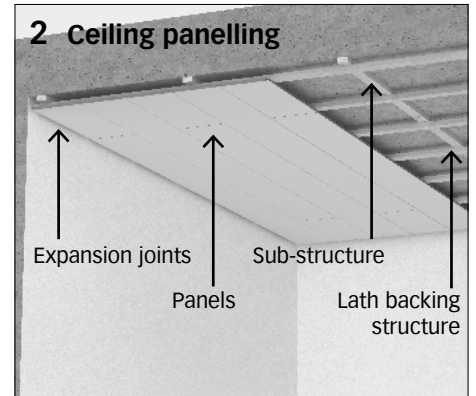
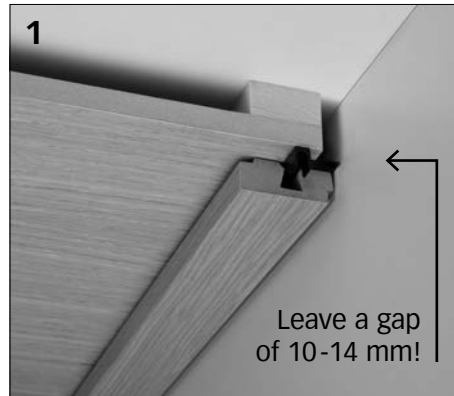
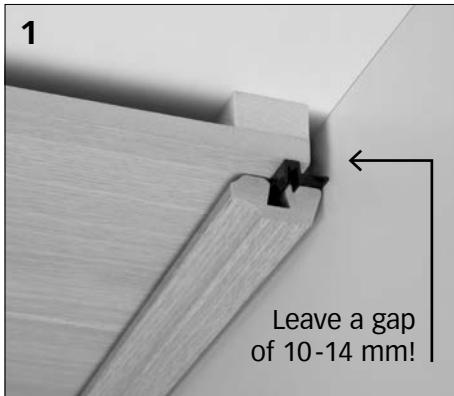

Position the first panel with the groove edge facing the centre of the room and fix it directly next to the wall using with standard countersunk head screws 3.0×30 mm in such a way that these will be covered later by the ceiling edging. Remember to leave an all-round gap to the wall of 10–14 millimetres. Now push the claw fitments into the panel groove and screw them to the sub-structure. Make sure the panel is fixed to each sub-structure lath with claw fitments. Push the tongue of the next panel into the groove and fix it as before with the claw fitments. Continue installing the planks row by row in this way.

Cut the last panel in each row so that you leave a gap of at least 10–14 millimetres to the wall. To cut the last row to size, use a spare piece of a plank and draw the remaining plank width on it (leaving a gap of at least 10–14 mm to the wall). Fix this panel next to the wall with standard countersunk head screws 3.0×30 mm in the same way as the panels in the first row. Use MEISTER ceiling edging to cover the

all-round expansion joints and to achieve a beautiful finish. MEISTER corner mouldings, hinged moulding strips, scotia mouldings and cover mouldings are also available to solve a whole variety of problems such as roof slope transitions, skylight edges, covering sills, etc. (pages 16|17).

Please ensure that no silicon products whatsoever come into contact with the mouldings.

For disassembly start with the last panel installed.

Cleaning and care

Occasionally clean MEISTER panels with a damp (well wrung-out) cloth that has been dipped in clean water. Do not use scouring liquid or powder, as these can damage the surface of the panels.



Wall and ceiling installation with the clip TOP 15 and the batten profile type 8

MeisterPanels. craft EP 500 | MeisterPanels. terra DP 250 | MeisterPanels. terra DP 200
MeisterPanels. bocado DP 300 | MeisterPanels. bocado DP 250 | MeisterPanels. bocado DP 200

Sub-structure with Type 8 batten profile

Place the Type 8 batten profile at maximum intervals of 40 centimetres apart (fig. 1). The profile is mounted crossways to the panel length and fixed so that there is an even sub-structure. Please use suitable plugs or screws to screw the sub-structure to the raw ceiling or wall at intervals of 40–50 cm. Correct any slight unevenness in the wall or ceiling by placing spacers or wooden wedges underneath the battens. Use a standard metal hacksaw or one-hand angle grinder with metal cutting disc to trim the profile. When using the Type 8 batten profile it must be noted that a minimum gap of 20 mm is required when installing MEISTER recessed lights. This must be guaranteed by fixing the profile to the wall/ceiling using a spacer of at least 12 mm.

Installation

Start by installing the first complete panel in the left-hand corner of the room with the tongues facing the wall. The tongue has to be sawn off the first panel on both the short and long edge. With all the next panels in the first row only remove the tongues along the long edges. In doing so leave a gap of 10-14 mm to the wall all around.

The row of panels is placed on the sub-structure (rails). The middle of the rail is marked using a pencil (fig. 2). Once this measurement has been transferred to the back, fix the start/end clip to the back of the panel with a gap of 2 cm to the outside edge using the supplied screws (fig. 3). The screws have to be fixed in the middle of the cut-out to allow for any inaccuracies to be corrected. Tighten the screws but do not over tighten them. If the clip does not slot in correctly then the profile may have been compressed during trimming. In this case please bend open the profile to its original dimensions again so that the start/end clip can be clearly heard clicking in (fig. 4).

Screw the first row of Top 15 onto the profile then push into the panel's groove and lock (fig. 5). Having aligned the first row of panels, fix the fixing clips with screws or rivets to prevent them being displaced during the rest of the installation.

Attach the next panel into the groove using the tongue and fix this using the Top 15 clip as before.

Continue installing the panels row by row in this way. Trim the last panels in every row so that there is at least a 10-14 mm gap to the wall.

The last row of panels can be mounted like the first one using the start/end clip.

To install the start/end clips on the last row mark the position of the batten profile using a piece of adhesive tape (fig. 6) and transfer the position of the profile onto the back of the panel.

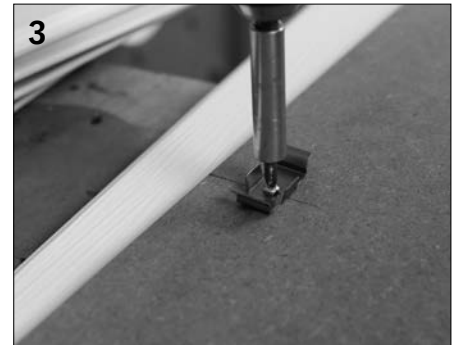
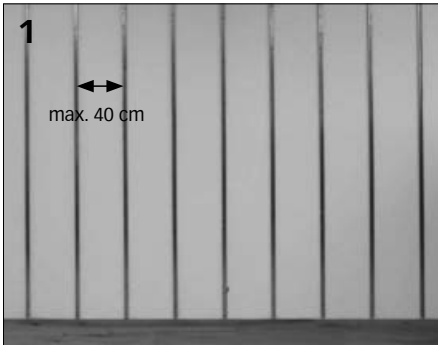

Installation and care instructions



Wall and ceiling installation with the MEISTER special screws No. 20

MeisterPanels. bocado DP 300 | **Meister**Panels. bocado DP 250

During installation, make sure there is air circulation behind the panelling (possibly provide a lath backing structure). You must avoid trapped air. Also important during installation is that you allow a gap of at least 10-14 millimetres (expansion joint) next to all walls and other fixed elements. (fig. 1).

For installation in damp rooms (e.g. bathrooms) please also note the following:

The panels may not be used in areas that will be directly splashed with water (e.g. shower, home swimming pool). Air circulation is absolutely necessary behind the panelling. If necessary, you must provide a lath backing structure to ensure no air is trapped. (Lath backing structure see fig. 2). Only use corrosion-proof metal fixing elements.

Start with the sub-structure. For this, attach dry laths that have if possible been planed on one side and that have a minimum cross-section of 20 × 40 millimetres. The laths should be placed at maximum intervals of 35 centimetres apart.

Install the laths crossways to the panel lengths and fix them to create an even sub-structure. Please use MEISTER lath screws or suitable plugs and screws to screw the sub-

structure to the ceiling or wall at intervals of 40-50 centimetres. Correct any slight unevenness of the wall/ceiling by placing small wooden wedges underneath the laths. If you intend to install the panels with offset ends, remember to provide a lath under each end joint for later fixing.

To avoid damaging the surfaces, observe the following instructions when sawing the elements: When you use a bench saw, keep the decorative side up, when using a keyhole or circular saw, keep the decorative side down.

MeisterPanels. bocado DP 300: With installation under the ceiling only use the MEISTER TOP 4 claw fitments as fixing material!

Start by laying the first complete panel in the left-hand corner of the room with the tongue sides facing the wall. You must saw off the tongues on the short and long edges of the first panel. Saw off only the tongues on the long edges of all the other panels in the first row. Position the first panel with the groove edge facing the centre of the room and fix it directly next to the wall using with standard countersunk head screws 3.0 × 30 mm in such a way that these will be covered later by the ceiling edge moulding. Remember to leave an

all-round gap with the wall of 10-14 millimetres. Now screw the panel onto the sub-structure at pre-set cut-out on the groove side using MEISTER special screws No. 20 (fig. 3/4). Please note that the screw head must be flush with the groove for proper installation and fit of the panels. You must avoid screwing through the groove. Alternatively, you can fix the panel with the TOP 4 claw screw.

With MeisterPanels. bocado DP 300 ceiling installation only fix panels using TOP 4.

Push the claw screw onto the panel groove and screw it onto the sub-structure.

Make sure the panel is fixed to each sub-structure lath with a MEISTER No. 20 special screw or a claw screw TOP 4. Push the tongue of the next panel into the groove and fix it as before with the MEISTER No. 20 special screws or claw screws TOP 4. Push the tongue of the first panel in the 2nd row into the groove (fig. 5). The panel is prevented from falling thanks to the special interlocking and therefore self-locking installation system (fig. 6). You can now very easily fix this panel onto the sub-structure using the MEISTER No. 20 special screw or claw screw TOP 4. Push the next panel in the 2nd row into the groove of the first row. To move it into the end groove, the panel must first be pressed down

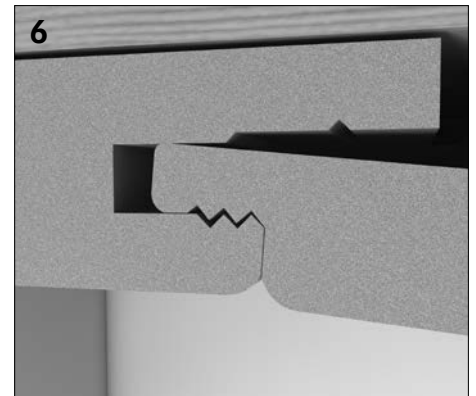
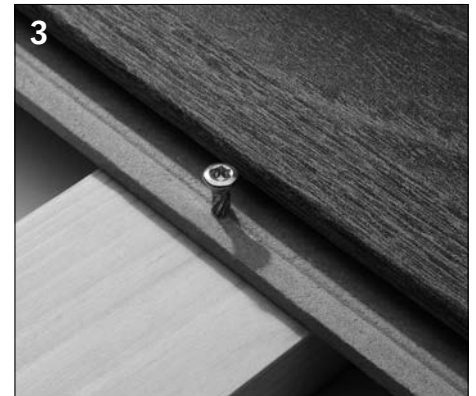
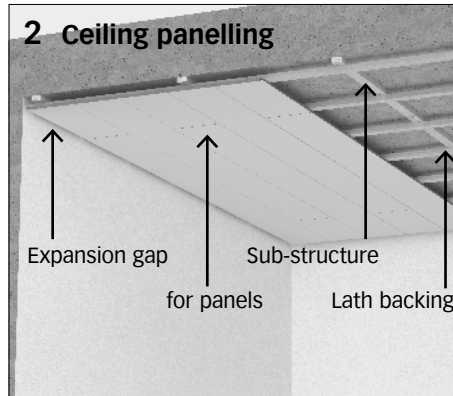
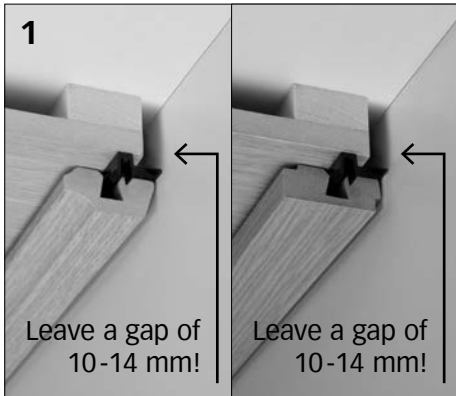

onto the sub-structure horizontally and then fixed as before. Install the panelling row by row in this way.

Cut the last panel in each row so that you leave a gap of at least 10-14 millimetres to the wall. To cut the last row to size, use a spare piece of a panel and draw the remaining panel width on it (leaving at least a 10-14 millimetre gap to the wall). Fix this panel next to the wall with standard countersunk head screws 3.0 × 30 mm in the same way as the panels in the first row.

Use MEISTER ceiling edgings to cover the all-round expansion joints and to achieve a beautiful finish. Ideal for a whole range of applications, e.g. roof slope transitions, skylight edges, covering sills etc. are MEISTER corner mouldings, hinged moulding strips, scotia mouldings and cover mouldings (pages 16|17).

Please ensure that no silicon products whatsoever come into contact with the mouldings.

With disassembly start with the last installed panel.

Cleaning and care

Occasionally clean MEISTER panels with a damp (well wrung-out) cloth that has been dipped in clean water. Do not use scouring liquid or powder, as these can damage the surface of the panels.

Installation instructions for fastening MeisterParquet. longlife PD 450, PD 400, PD 200, PC 200, PS 300, PC 400 (clip TOP 13) and Lindura wood flooring HD 400 (clip TOP 11) to the wall

Preparatory measures

The packages must be acclimatised before you open them. Store them for approx. 48 hours (3-4 days in winter) flat on the floor in the centre of the room you want to work in. Do not store the packages in front of damp or freshly wallpapered walls. Before you install the planks, the conditions must comply with the general requirements for the installation of wooden materials in interior rooms. Make sure that the walls are dry, i.e. contain a maximum residual moisture of 5 percent. All windows and doors must also have been installed and a room temperature of approx. 20°C and approx. 30 – 65 percent relative humidity must prevail.

During installation, make sure that air can also circulate behind the wood panelling (possibly provide lath backing structure). You must avoid trapped air. It is also important during installation that you allow a gap of at least 10 – 15 mm next to all walls and other fixed elements. You need an expansion joint if your installation surface is longer or wider than 10 metres.

Sub-structure with batten profile type 8

Place the batten profile type 8 at maximum intervals of 40 centimetres apart (fig. 1). Please use suitable plugs or screws to screw the sub-structure to the wall at intervals of 50 cm. Correct any slight unevenness in the wall by placing spacers or wooden wedges underneath the laths. Use a standard metal hacksaw or one-hand angle grinder with metal cutting disc to trim the profile. A minimum gap of 20 mm is required when installing MEISTER recessed lights. This must be guaranteed by fixing the batten profile to the wall using a spacer of at least 12 mm.

Installation

As a result of the MasterclipPlus system the planks are installed from right to left (fig. 9). Start by laying the first complete plank with the tongue side facing the floor. With all the planks in the first row remove the tongues along the long edges.

To install the first row use the start/end clip. To fix these mark the profile's position on the back of the plank. The middle of the rail is marked using a pencil (fig. 2) and the start/end clip is fixed using the supplied screws (fig. 3). Tighten the screws but do not overtighten them. Then simply clip the plank into the batten profile (fig. 4). If the clip does not slot in correctly then the profile may have been pressed together during trimming. In this case please bend open the profile to its original dimensions again. Use the TOP 13|TOP 11 clip to fix the planks for the rest of the installation. For this simply screw the clip onto the batten profile (fig. 5) and push it onto the plank groove (fig. 6 + 7). Make sure that the planks in the first row are straight.

Angle the tongue of the first plank in the second row into the groove of the previous row of planks (fig. 8) and slowly press the planks onto the batten profile. Use the TOP 13|TOP 11 clip to fix the planks for the rest of the installation (fig. 7). Continue installing the planks row by row in this way (fig. 10). To cut the last row to size use a spare piece of a plank and draw the remaining plank width on it (leaving a gap of 10-15 mm to the ceiling).

Taking the plank marked for width, push the plastic end tongue forward out of the end groove using the spare piece of plank (fig. 11). Begin cutting the plank to size at the end of the plastic tongue. After the plank has been cut to size, push the plastic tongue on the end back into the end groove (fig. 12 + 13).

To install the start/end clips on the last row mark the position of the batten profile using a piece of adhesive tape (fig. 14) and transfer the position of the profile onto the back of the plank (fig. 15 + 16). Now the clip is fixed on the plank in the first row (fig. 17) and inserted into the plank (fig. 18). Afterwards the plastic tongue in the last row must be fixed using a screwdriver (fig. 19).

Use the MEISTER angled cover moulding for example to cover the all-round expansion joints (fig. 20+22).

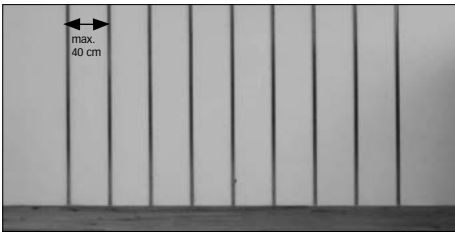

Fig. 1



Fig. 2



Fig. 3



Fig. 4

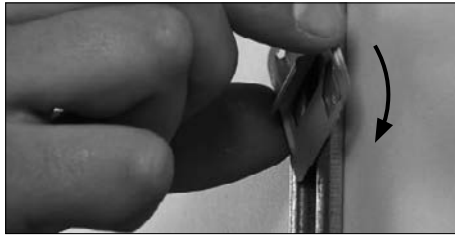

Fig. 5

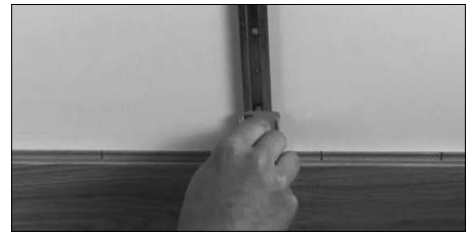

Fig. 6

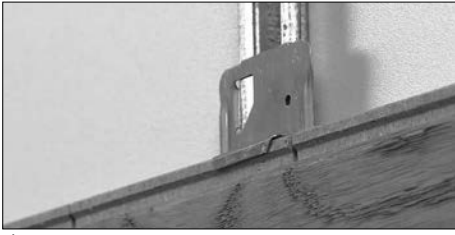

Fig. 7



Fig. 8



Fig. 9



Fig. 10

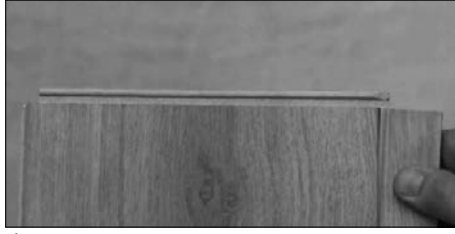

Fig. 11



Fig. 12



Fig. 13



Fig. 14



Fig. 15

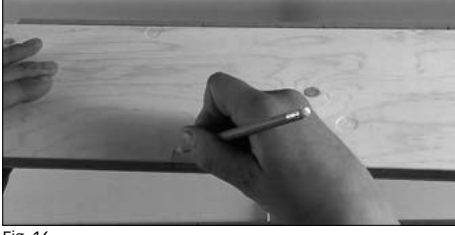

Fig. 16



Fig. 17



Fig. 18

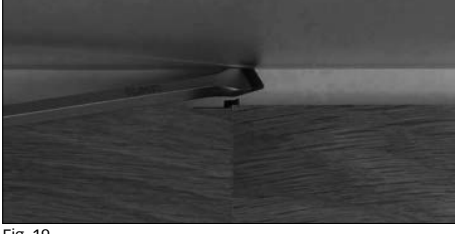

Fig. 19



Fig. 20



Fig. 21

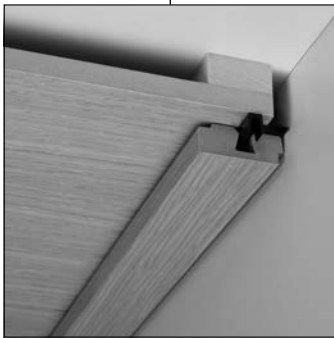
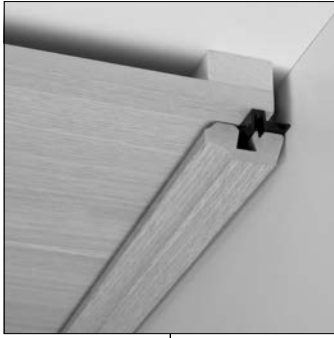

Fig. 22

Mouldings

Summary of MEISTER mouldings

With ceiling edge mouldings, wall mouldings and skirting boards you have everything perfectly in place. Practical, clever and easy to install.



Ceiling edge mouldings

The ceiling edge mouldings guarantee a smooth finish for walls and ceilings:

- | Uneven wallpaper edges are no longer visible thanks to the bevelled edge.
- | The shadow joint required for installation is covered.
- | As a result of the shadow effect, the ceiling edge mouldings can also be easily installed with uneven walls.

MEISTER attachment clips enable the fast and invisible fixing of mouldings. The square ceiling edge moulding is particularly suitable for panels MeisterPanels. nova SP 300 and MeisterPanels. bocado DP 300.

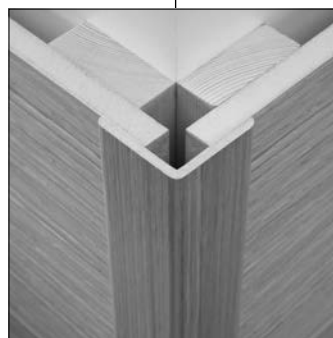

Angled mouldings

Angled mouldings are the ideal corner connectors for 90° outer corners. In combination with panelling they can be attached or inserted into the groove. As a decorative element they can be used in a variety of ways throughout the whole living area.



Cover mouldings

Cover mouldings are the perfect finish for many interior areas: e.g. stairwells, half-height panelling, door cladding, skylights and side surrounds of ceiling panelling that is not laid wall to wall.

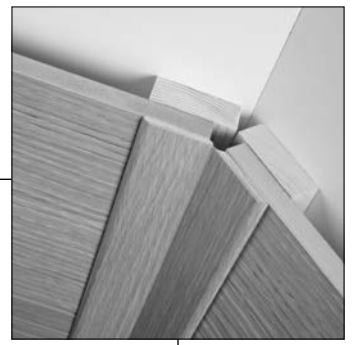

Hinged mouldings

Hinged mouldings are ideal for angled solutions, between 10° and 270°, e.g. roof slopes or inner corners.

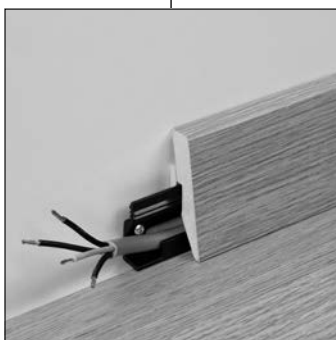

Skirting boards

Skirting boards are used with their classic profiles as a finish between the floor and wall in the whole flooring area.

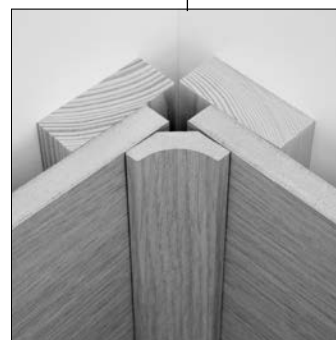

Scotia mouldings

Scotia mouldings have many uses, e.g. as a corner connection with panels and as a skirting board.

© 2020 by MeisterWerke Schulte GmbH

For reasons of printing technology, colours and structures may vary from the reproductions shown here.
We reserve the right to make changes. No responsibility is assumed for errors.

MEISTER – a trademark of MeisterWerke Schulte GmbH

Johannes-Schulte-Allee 5 | 59602 Rùthen-Meiste | GERMANY

Phone +49 2952 816-0 | Fax +49 2952 816-66 | www.meister.com

GB